

NOTES

MATERIAL - DIECAST ALUMINUM ALLOY  
 - FOUR M9 CAPTIVE SCREWS

POWDER COATED - Col. RAL 7032  
 POLYURETHANE GASKET  
 -40°C TO +80°C TEMP. RANGE

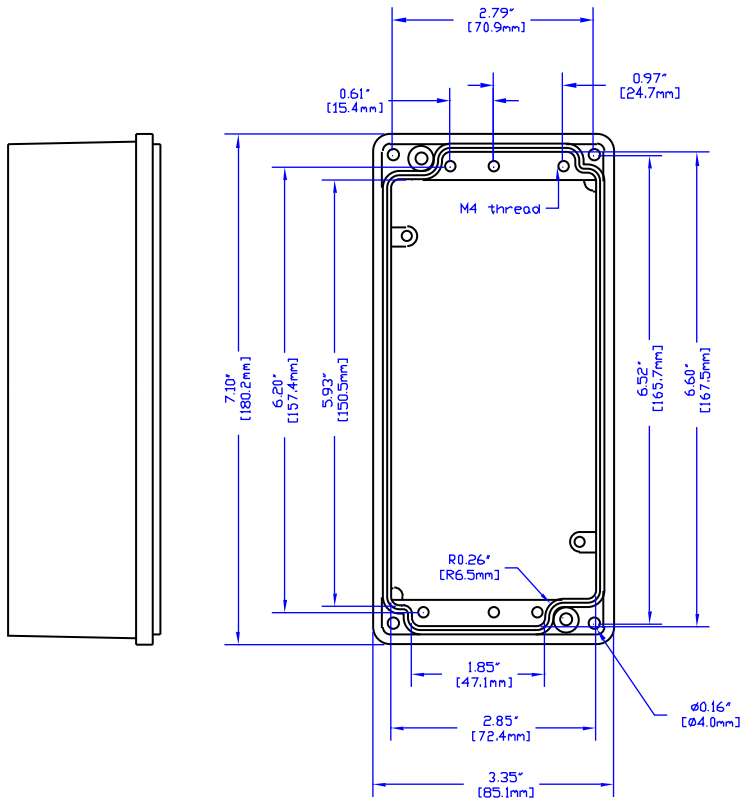
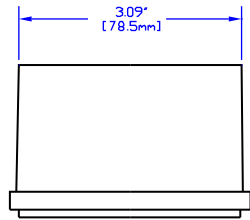

VIEW OF BOX (LID REMOVED)

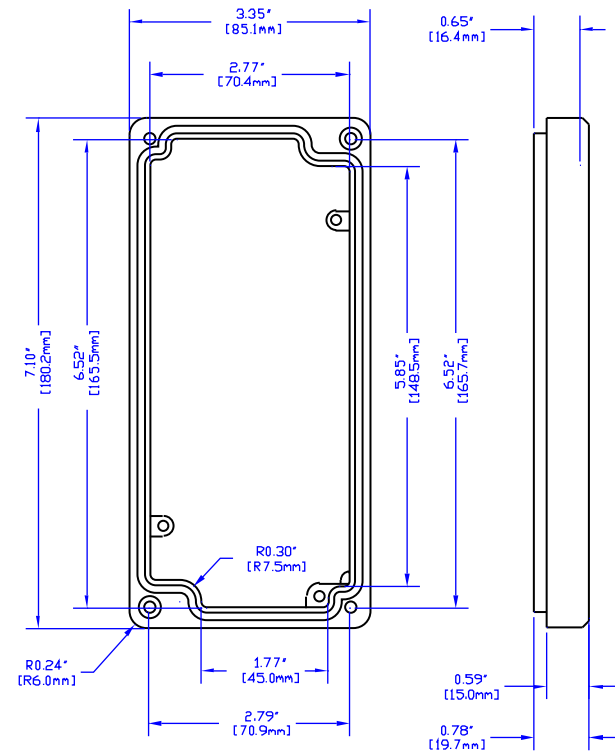
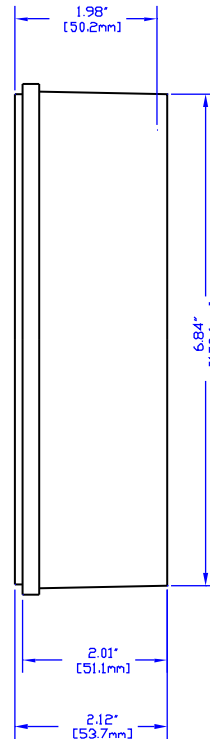

VIEW OF LID (INSIDE)



HAMMOND MANUFACTURING

R110-083-000